



DESIGNED SECURITY, INC.

*A Detex Company*

## **DS500 Waist High Turnstile**

### **Service & Installation Manual**



**Note: Successful turnstile installation depends on reading this manual.**

*Please keep this service manual after installation. If an installation is done by a construction company or outside installer, please pass this book along to the end user. This book is required for maintenance, troubleshooting & repairs.*

## Important Electrical Information

Installation of the control head mechanism into the turnstile requires a grounding-type outlet receptacle installed inside of the frame or cabinet through the provided conduit access points.

To reduce the risk of electric shock, this equipment has a grounding type plug that has a third (grounding) pin. This plug will only fit into a grounding type outlet. If the plug does not fit into the outlet, contact a qualified electrician to install the proper outlet. Do not change this plug in any way.

Additionally, the P24-60W power supply from this appliance must be grounded to the frame of the turnstile. Utilize the green colored grounding screw threaded into the grounding tab located near the power supply along with the provided grounding wire from the power supply to ensure the equipment is properly grounded.

Do not connect to a receptacle controlled by a switch.

UL 294 Classification Declarations:

<b>Feature</b>	<b>Level</b>
Destructive Attack Test	I
Line Security	I
Endurance	IV
Standby Power	I

ULC S319, Class 1

Wiring methods shall be in accordance with:

National Electrical Code, ANSI/NFPA 70

Canadian Electrical Code, CSA C22.1, Part I, Safety Standard for Electrical Installations

The 6500 Series Control Head is suitable for indoor & outdoor use, within in an appropriate turnstile or gate model.

## Table of Contents

Important Electrical Information	2
Model Datasheet	4
Preinstallation Tips	6
Installation Instructions	7
Concrete Anchor Information	8
Mechanical Overview	9
Internal Parts Breakdown	10
Parts List	11
Control Head Configurations	12
Locking Bar Information	13
Hydraulic Shock & Indexing	15
Electrical Introduction	16
Wiring Diagram	17
Wiring Legend	18
Logic Controller Settings	19
Testing Procedure	20
Limit Switch & Limit Switch Cam Information	21
Maintenance & Cleaning	22
Troubleshooting	23
Proper Turnstile Usage	26
Warranty	27
Appendix	

# The DS500 Series

Bolt Down | Interior & Exterior Application

## Waist-High

DS500  
DS500-C | DS500-T

The DS500 Series is made for years of reliable service in high traffic/volume applications like stadiums, convention centers, landmarks and military bases. Thousands are currently in use at leading pro-sports venues, amusement parks and high-profile attractions worldwide.

The cabinets are constructed of heavy 14-gauge, 300 series satin stainless steel and features our 6500 Series Control Head (with auto indexing and shock suppression technology). The cabinets can be interfaced with optional LCD counters, card readers, push button, and wireless remotes.

We offer a matching ADA compliant handicap gate with this series (DS500-ADA).



DS500



DS500-C (coin)



DS500-T (ticket box)



# The DS500 Series

Bolt Down | Interior & Exterior Application

# Waist-High

DS500  
DS500-C | DS500-T

## Applications:

This series is made for years of reliable service in high traffic/volume environments like stadiums, convention centers, amusement parks, landmarks and military bases.

## Product Features:

Material:

- Our signature 304 stainless steel/ No. 4 satin finish

## Design & Construction:

- Designed for secure and reliable operation with aesthetics in mind
- Cabinet constructed of 304 stainless steel/ No. 4 satin finish
- Arms constructed with 1 5/16" (33.4mm) diameter, (12 gauge) stainless steel
- Hub 4 1/2" (114.3mm) o.d. also made from stainless steel
- Minimal exposed hardware

## Dimensions:

- Height: 38.062" (966.8mm)
- Width (standard): 23.437" (595.3mm)
- Width (-C/-T): 23.218" (589.7mm)
- Depth (standard): 27.437" (696.9mm)
- Depth (-C/-T): 33.437" (849.3mm)

\* Dimensions are subject to change without notice



Our matching ADA gate (DS500-ADA with optional motorization) is available for the FastPass Series.

## Operation Features

### 6500 Series Control Head:

- Auto-indexing (self-centering) with adjustable hydraulic shock suppression
- Hardened tool steel locking bars, cam and roller assemblies
- Permanently lubricated bearings
- Your choice of manual or electronic control on both directions
- Nearly universal integration to any number of access control systems
- Your choice on each electronic direction of locking or unlocking on power failure

## Options:

- Daylight visible indicator lights
- Bi-directional key overrides
- 8 digit key resettable LCD counter with seven year lithium battery
- Coin/token acceptor
- Bill acceptor
- Ticket drop box
- Additional options available upon request

## Warranty:

Units are warranted against defects in materials and workmanship for a period of one year from date of delivery. See warranty information for specific details.

## Electrical Specifications:

Input Voltage: 100-240 VAC  
Input Current: 1.3 - .55 A  
Frequency: 50/60 Hz  
Storage Temperature: -40 to 158°F  
Operating Temperature: -4 to 131°F  
Operating Voltage: 24VDC  
Operating Current: 1.2 A (typical)

## Standards and Codes:

Austenitic stainless steel:  
ASTM A240, A249, A276  
Hot rolled steel:  
AISI C-1020, AISI C-1018  
All fasteners provided meet IFI ANSI/ ASME Fastener Standards  
American Welding Society (AWS) Standard D 1.1



The 6500 Series Control Head is certified to conform to the following standards:  
UL 294, UL 325, UL Subject 2593, CAN/ULC S319 & CSA C22.2#247

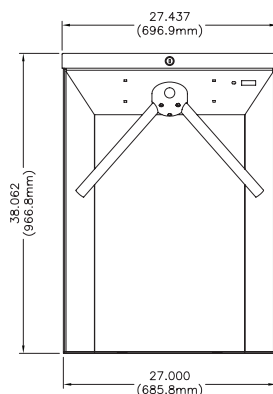

(DS500)

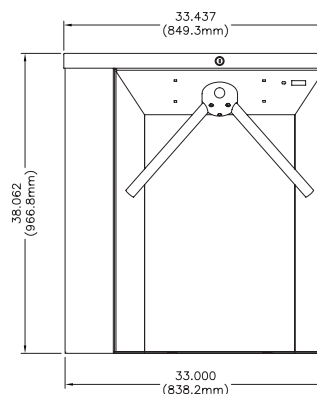

(DS500-C-T)

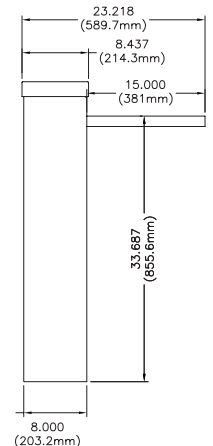

\* Dimensions are approximate

## Pre-installation Tips

To ensure an easy installation, please review the following tips before trying to install the unit.

### Lid Removal

The top lid on most of our waist high models is held in place on the front side with a lock and two hooks that connect to the cabinet on the rear. After the lock has been released, the rear hooks can be unlatched by pulling the lid from the back side forward then pivoting upwards in one motion.

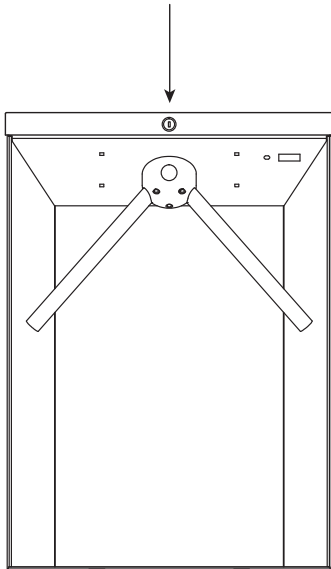

Step 1: Unlock Lid

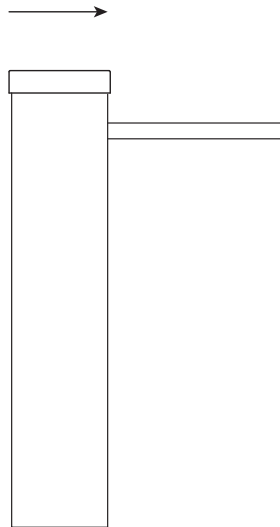

Step 2: Pull lid forward

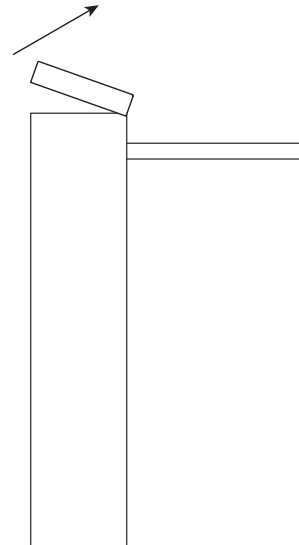

Step 3: Pivot up in back while pulling forward.

### Front Panel Removal

In order to access the bolt holes for anchoring the cabinet to the floor, the decorative front panel needs to be removed. This is accomplished by removing the two 10/32 phillips screws that connect the front panel to the cabinet located at the upper inside of the cabinet.

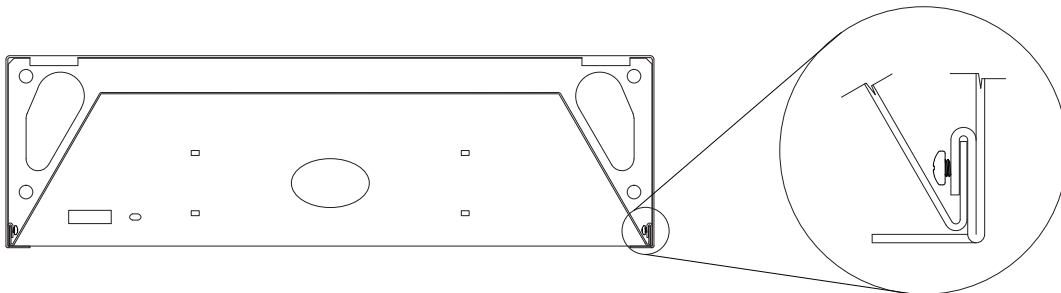

## Waist High Cabinet Installation Instructions

Place upright cabinet with front panel removed onto a level surface +/- 1/16". If the surface is not level, the cabinet must be shimmed. Bolting a turnstile or ADA gate to an uneven floor may cause it to work improperly.

Mark or punch the floor using the four anchor holes on the floor plate as a template and drill four 3/8" holes approximately 4" deep. Remove all concrete dust from the holes.

Place the cabinet back in its intended location and install with the provided 3/8" concrete anchors. Torque the nuts with a minimum of 25 foot pounds. If unsure, refer to the following page for anchor installation tips.

If electronically controlled, install grounded electrical outlet within the cabinet and ground the power supply to the cabinet frame with provided grounding wire.

Install access control devices and/or fire alarm overrides to the control board with the wiring diagram provided later in this manual.

Install arm assembly (if applicable) to the arm adapter utilizing the three 5/16-18" socket head cap screws. We recommend applying removable strength (blue) thread sealant such as Loctite 243 to these screws.

Test the turnstile or ADA gate for proper functionality, making adjustments to the hydraulic shock absorber as needed (reference hydraulic shock information later in this manual).

Reinstall the front panel and lid on the cabinet then provide this manual to the end user or leave within the cabinet for future reference.

# Wedge Type Concrete Anchor Instructions

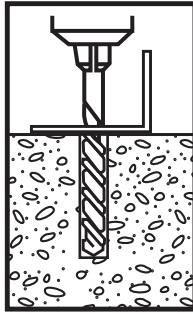

**1**

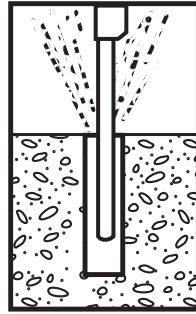

**2**



**3**



**4**

- 1** Select a carbide drill bit with a diameter equal to the anchor diameter. Drill hole at least 1/4" deeper than nominal anchor embedment.
- 2** Clean hole with pressurized air or vacuum to remove any excess dust/debris.
- 3** Using the washer and nut provided, assemble the anchor, leaving nut one half turn from the end of anchor to protect threads. Drive anchor through fixture to be fastened until washer is flush to the surface of fixture.
- 4** Expand anchor by tightening nut to the specified setting torque - see Table (approx 3 to 5 full revolutions).

Anchor Diameter & Drill Bit Size	Installation Torque Ft. lbs.*	Minimum Anchor Embedment	Minimum Hole Diameter in Fixture
3/8"	25	1-7/8"	1/2"
1/2"	45	2-1/2"	5/8"
5/8"	90	2-3/4"	3/4"

\* Setting torque only applies at the time of installation.

Warning!

- Use in concrete ONLY. Not recommended for use in lightweight masonry such as block or brick.
- Always wear safety glasses and other necessary protective devices or apparel when installing or working with anchors.

Caution: Use of core drills is not recommended to drill holes for use with this anchor.

Do not use an impact wrench to set or tighten the anchor. Not recommended for use in concrete which has not had sufficient time to cure.

The use of carbide drill bits manufactured with ANSI B212.15 drill bit diameter requirements is recommended for installation of this anchor. Anchor spacing and edge distance (anchor installation locations) are the responsibility of the engineer of record.

Installing product in oversized holes is not recommended. Product will not set properly or achieve full designed load in oversized holes.



## 6500 Series Control Head Mechanical Information

All of our turnstiles and ADA gates operate with a mechanism called the 6500 Series Control Head. This sturdy and easy to maintain drive for the turnstile has replaced all previous model control heads. It is adaptable to nearly any existing turnstile and comes with each new turnstile purchase. This control head can be configured in multiple ways to accommodate the security requirements of each individual job site.

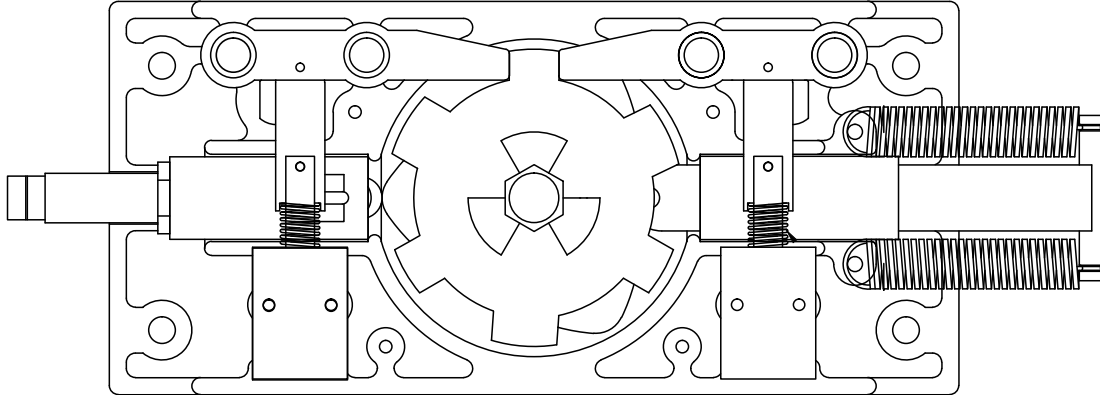

*An internal view of an electronically controlled two way 6500 series control head.*

While the head can be configured for mechanical (no electronics) operation, a turnstile's security potential is reached in the case of an electronic two way control head. In this instance, each rotational direction is independently unlocked. Configured properly, a control head will allow for one rotation per valid entry request. Our anti-backup cams are designed so that it is mechanically impossible to become trapped within the turnstile when properly installed.

Each control head comes preconfigured to your specific needs based off of a directional sheet that is filled out before shipment. The heads are delivered pre-wired, tested and adjusted to our factory recommendations. Installation is simple: connect inputs from access control devices into the logic controller and plug the unit's power supply into a 100-240 VAC (single phase) receptacle. The power supply will automatically set itself to function on your local voltage and convert it to 24VDC.

TOP CASTING REMOVED

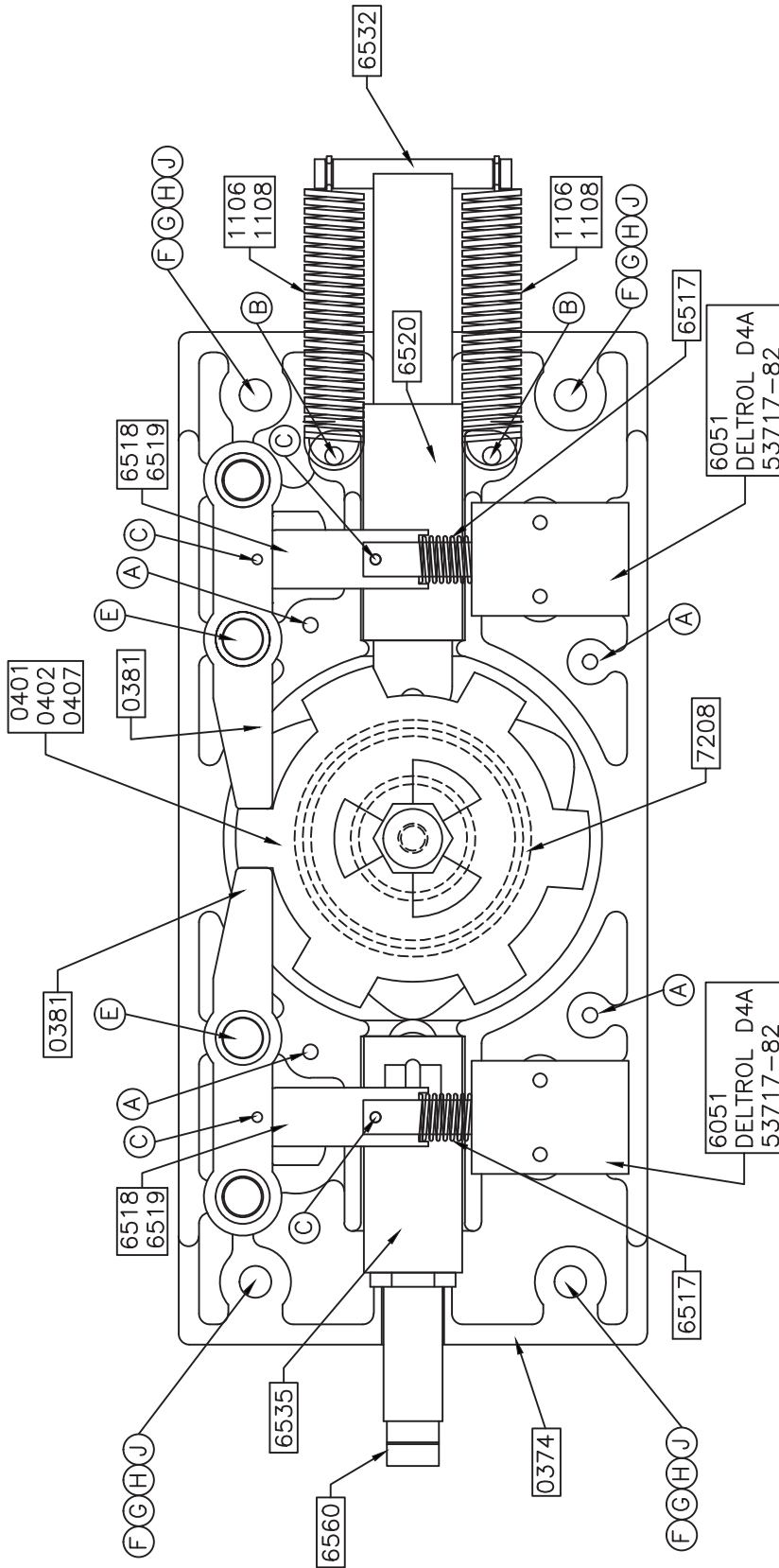

ALL ELECTRICAL COMPONENTS UL CERTIFIED







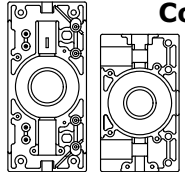
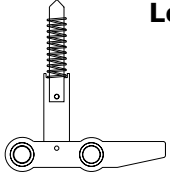
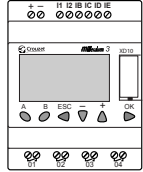
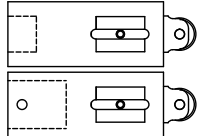

NOTE:  
ALL WIRE AWG 18 GAUGE 300 VAC  
UL 1007/1569

SYM	QTY	DESCRIPTION
(A)	4	1/4-20 x 1" SOCKET HEAD
(B)	2	1/4"φ x 1 1/4" SPRING PIN
(C)	4	1/8"φ x 5/8" SPRING PIN
(E)	2	1/2"φ X 2 1/4" DOWEL PIN

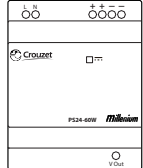
WAIST HIGH UNITS		
(F)	4	5/16 x 1-1/2" SS CARRIAGE BOLT
(G)	4	5/16 SS FLAT WASHER
(H)	4	5/16 SS LOCK WASHER
(J)	4	5/16 SS HEX NUT

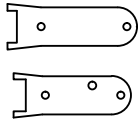
FULL HEIGHT UNITS		
(F)	4	3/8" x 1-1/2" SS CARRIAGE BOLT
(G)	4	3/8 SS FLAT WASHER
(H)	4	3/8 SS LOCK WASHER
(J)	4	3/8 SS HEX NUT

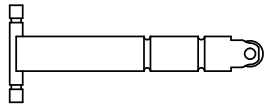
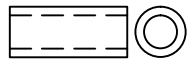
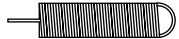
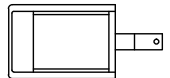
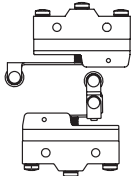
6500 SERIES CONTROL HEAD BOTTOM ASSEMBLY

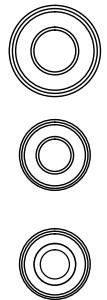
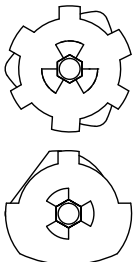
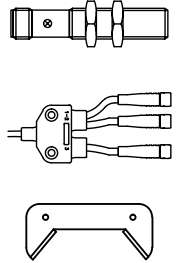
 <p><b>Control Head Castings</b> 0373 - Bottom Casting 0372 - Top Casting</p>	 <p><b>Locking Bar Assemblies</b> 0382 - Fail Open Assembly 0383 - Fail Lock Assembly</p>	 <p>0740 - Logic Controller (XD10)</p>
 <p><b>Shock Housing Assemblies</b> 6535 - WH/427/430/T80/ADA 6541 - 439/448/P60/HD</p>	 <p><b>Hydraulic Shock Absorbers</b> 6560 - WH/427/430/T80/ADA 6561 - 439/448/P60/HD</p>	 <p>0750 - 24VDC Power Supply (60 W) w/ NEMA 5-15 Drop Cord</p>
 <p>0381 - Locking Bar Casting w/ Oil Impregnated Bushings</p>	 <p><b>Locking Bar Linkages</b> 6519 - Fail Open 6518 - Fail Lock</p>	 <p><b>Solenoid Springs</b> 6510 - Fail Open Spring 6016 - Fail Lock Spring</p>
 <p>6532 - Index Pin</p>	 <p>6520 - Index Pin Tubing</p>	 <p><b>Indexing Springs</b> 1106 - Waist High (Light) 1108 - Full Height (Heavy) 1107 - ADA (Extra Heavy)</p>
 <p>6051 - Solenoid Deltrol D4A53717-82</p>	 <p><b>Limit Switches</b> 2180 - Standard (Z-15GW2-B7-K) 1700 - One Way (BZ2RW825-A2)</p>	 <p><b>Limit Switch Cams</b> 2267 - Standard 2268 - ADA 2269 - One-Way</p>
 <p><b>Control Head Bearings</b> 7208 - Bottom Casting (6007RSNR) 1641 - 1" ID for HD Top Castings &amp; All Pre-2018 Tops (1641-2RSNR) 1640 - 7/8" ID for Standard Duty Top Castings (1640-2RSNR)</p>	 <p><b>Cam Assemblies</b> 0401 - 427/430/T80/WH (7/8 Hex) 0407 - 439/448/P60/HD (1.25" Hex) 0402 - ADA (Must specify model)</p>	 <p><b>Proximity Sensor &amp; Accessories</b> 7211 - 24VDC PNP Prox. Sensor w/ M12 Connector (Sick 1040763) 0766 - 3 Branch M12 Splitter 6589 - Turnstile Prox. Bracket w/ 3x Mounts - LH, RH &amp; Home</p>

## 6500 Series Control Head Configurations

The 6500 Series Control Head can be configured in a number of different ways. All units operating with the 6500 Series Control Head self-center with a spring driven indexing pin and hydraulically shock to the home position to prevent damage or injury.

Various configurations are available to suit the needs of any environment. These include:

**Manual both ways:** Unit rotates freely in both directions. This unsecure configuration is used as a means to direct traffic through one area. Full height turnstiles can be also be purchased with an out of service lockout bar which would allow the end user to lock the turnstile with a standard pad lock.

**Manual one way:** Turnstile rotates in one direction but not the other. This is often used for egress only areas.

**Electronic one way with free exit:** Unit rotates freely in one direction but requires some form of access control in the other. This is a typical installation in many facilities that want to control who is entering but want egress to be free flowing.

**Electronic one way with no exit:** Turnstile is locked in both directions at all times, but in one direction can be unlocked with access control. Typically, this would be installed in scenarios where there is an alternate means of exiting the facility.

**Electronic two way:** Turnstile requires access control for both entering and exiting a facility. This configuration offers the highest level of security and also flexibility for installations.

**Fail lock:** Upon power failure, an electronically controlled direction would remain locked. This offers a high level of security but typically is not a good idea for egress unless alternate methods of exiting are available. Unless equipped with key overrides, this can be easily converted to fail open by ordering alternate parts. This is also known as fail secure.

**Fail open:** Upon power failure, an electronically controlled direction would remain open. This is the most common configuration as it allows for secure access controlled passage in normal situations but in power outages it free wheels. Unless equipped with key overrides, this can be easily converted to fail lock by ordering alternate parts. This is also known as fail safe.

**Key override:** This option is available on either electronic or manual two way models. It can allow for a quick reconfiguration of free flowing passage or locking in either direction. The key override option is not intended for constant every day use. Should you require an additional lock-down feature on your turnstile, a better option (on a full height turnstile) is an out of service lockout with a standard pad lock. Note that the key override option makes conversion between fail lock and fail open very difficult to accomplish and also may not be available for some turnstile or gate models.

## 6500 Series Control Head Locking Bar Information

The 6500 Series Control Head is built to order based on a direction set up sheet sent with each quote. This sheet defines how each direction of passage functions.

Direction 1 is defined as clockwise rotation on a full height or with the cabinet on the right for waist high. Direction 2 is defined as counter-clockwise rotation on a full height or with the cabinet on the left for waist high.

Possible configurations include: no passage, free passage (manual), fail lock and fail open. Fail lock and fail open are not field reversible without additional components.

“No passage” directions include a fail lock locking bar assembly as well as an unwired solenoid. This adds the appropriate parts to the control head to prevent it from rotating in that direction.

“Free passage” (or manual) directions remove the solenoid and locking bar assembly, allowing the cam to spin freely.

Each direction has a pair of holes on the locking bar and control head casting. These holes act as pivot points for the locking bar casting. The inner holes are fail lock and outer holes are fail open. A .5" dowel pin slides through the entire assembly to hold everything in place.

Alternate linkages and springs are needed to convert a direction's power failure status.

If optional key overrides are included, it becomes much more difficult to re-arrange the configuration. Typically it is best to send the control head into the factory to reconfigure any key override equipped head to ensure everything is done correctly.

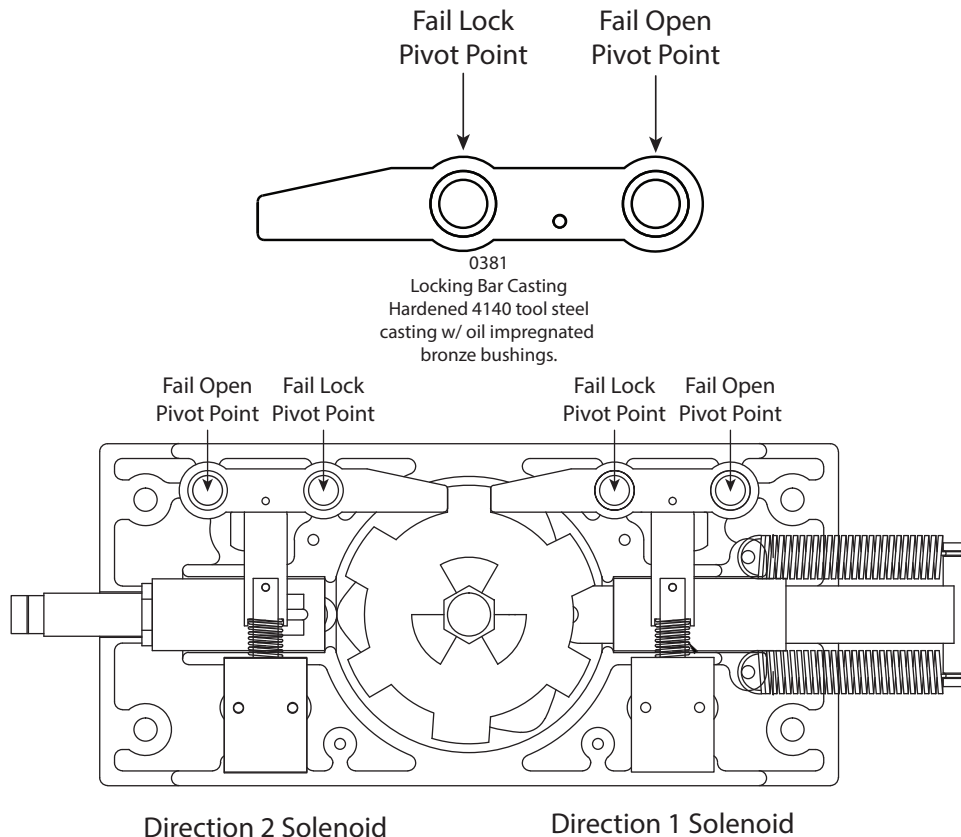

## 6500 Series Control Head Locking Bar Information (Continued)

The 6500 Series Control Head can be reconfigured from fail lock to fail open and vice versa. Extra components are required to do so.

If a control head has key overrides, we suggest sending it in for factory reconfiguration.

Locking bar assemblies are held together with 1/8" spring pins. Extracting these pins and reinstalling them can be tricky, so for convenience we also offer entire locking bar assemblies.

Replacing an entire locking bar assembly is simple; punch the .5" dowel pin from the pivot point through the head casting (via a small hole in the bottom casting for this purpose), pull out the old locking bar assembly and replace it with the new one.

If changing from fail lock to fail open or vice versa, install the dowel pin in the alternate hole.

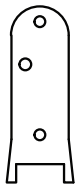

6518

**Fail Lock Linkage**  
These have an approximate length of 2.25" and also include an extra hole the key override option.



6010

**Fail Lock Solenoid Spring**  
These look the same as the fail open, but are actually lighter in force. Wire diameter is .032". This spring was also used on the 6100 Series Control Head.

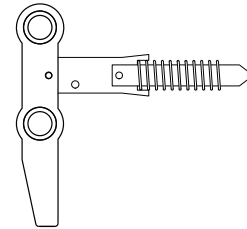

0383

**Fail Lock Locking Bar Assembly**  
Includes locking bar casting w/ oil impregnated bushings, solenoid spring, locking bar linkage, and solenoid plunger.



6519

**Fail Open Linkage**  
These have an approximate length of 2.5" and do not have the extra hole for the key override option.



6510

**Fail Open Solenoid Spring**  
These look similar to fail lock, but are actually stronger in force. Wire diameter is .041".

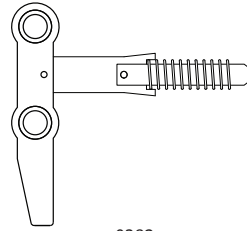

0382

**Fail Open Locking Bar Assembly**  
Includes locking bar casting w/ oil impregnated bushings, solenoid spring, locking bar linkage, and solenoid plunger.

Make sure the solenoid spring is between the alignment tabs on the linkage or the assembly may bind when pivoting.

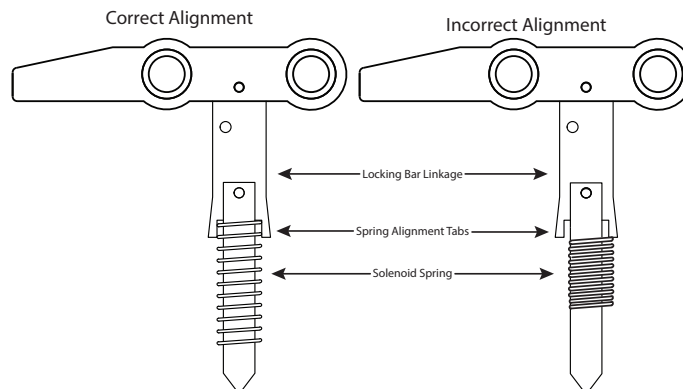

## 6500 Series Control Head Hydraulic Shock Information

The 6500 Series Control Head utilizes a spring loaded index pin for auto-centering the cam while a hydraulic shock offers counter resistance to slow the rotation down.

Set properly, the shock will allow a turnstile or gate to self-center while rotating smoothly without slamming.

Some turnstile models use a different shock than others. Waist highs and smaller full heights use a .75" diameter shock while larger full heights use a 1" diameter shock.

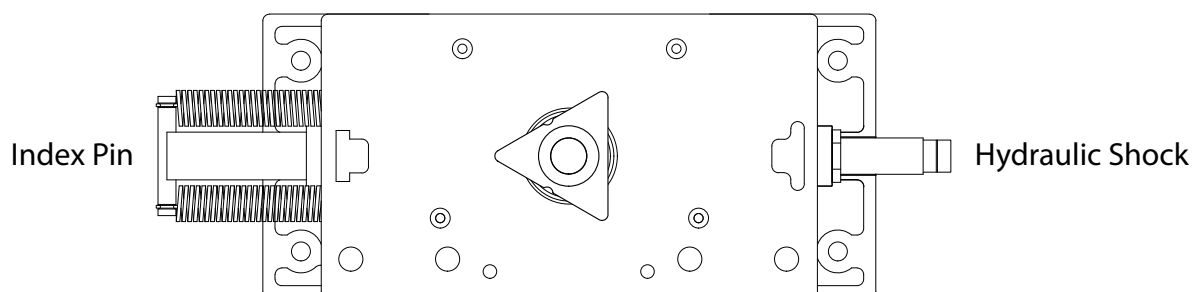

### 3/4" Hydraulic Shocks:

#### Setting:

Loosen the set screw on the head of the dial and turn the knob. The dial can be set between 0 and 8. The higher the number, the stronger the shock is. Tightening the set screw can alter the shock strength so a good habit is to loosen the set screw, turn the dial, tighten the set screw then test your setting. Repeat until satisfied.

#### Replacement:

Thread the new shock into the shock housing as far as it will turn while the cam is in the home position. Once it bottoms out, thread the shock back out 1.5 - 2 turns until the numbers on the dial are facing upright. Some models may require an additional turn or two outward if the arm does not self center on even the lowest setting.

### 1" Hydraulic Shocks:

#### Setting:

Loosen the set screw on the head of the dial and turn the knob. The dial can be set between 0 and 8. The higher the number, the stronger the shock is. Tightening the set screw can alter the shock strength so a good habit is to loosen the set screw, turn the dial, tighten the set screw then test your setting. Repeat until satisfied.

#### Replacement:

Thread the new shock into the housing as far as it will turn while the cam is in the home position. Once it bottoms out, thread the shock back out 1.5-2 turns until the set screw pointer is facing upright. Fasten the shock into the housing by snugging the 1/4-28 set screw into the bronze housing (snugly, but do not over tighten or the brass might start to tear).

**Failure to turn the shock back out after threading it in all of the way will likely cause the part to wear out very quickly.**

# 6500 Series Control Head Electrical Information

Each electronic control head comes with a power supply, a programmable logic controller (PLC), limit switches (or optionally, proximity sensors) and solenoids. For safety purposes, it is recommended that you read all literature on the electrical components before attempting to install the control head into a turnstile.

The 6500 Series Control Head is on the third generation of electronic components. The new XD10 logic controller is a direct replacement of both the 0789 control board and 6789 (Keyence KV-16DR) logic controller.

The latest enhancements provide a broader temperature range for outdoor installations (-4 to 131F) as well as a user friendly text based interface with a daylight visible display. With this also comes some new features such as on board testing buttons, turnstile statistics / information, etc.

While the wiring may be different, there are very few exceptions to when this board is compatible with installed products. If an installation has the old 0789 circuit board (PCB) and has the optional proximity sensor upgrade, new proximity sensors will need to be purchased. This is because the 0789 board had NPN inputs while the XD10 (and the KV-16DR) have PNP inputs.

The new PLC still requires relay contact closures for inputs just like all previous generations, so any installation is compatible in one way or another. If assistance is needed with understanding how to convert the wiring from access control to the new logic controller, please view this manual or call our technical support department for assistance.

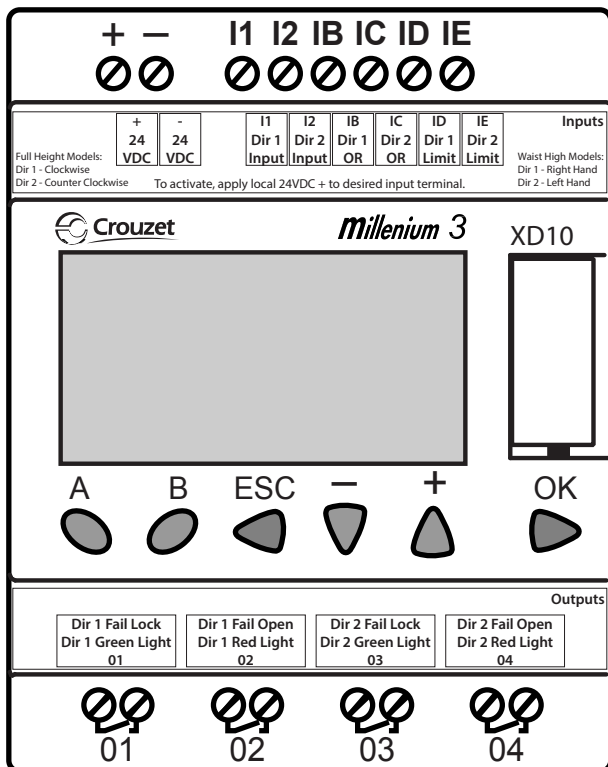

XD10 Logic Controller  
0740

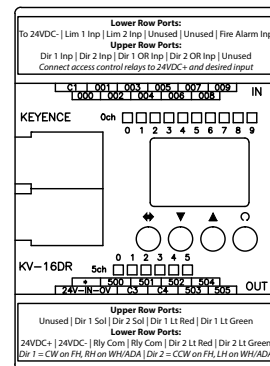

KV-16DR Logic Controller  
6789

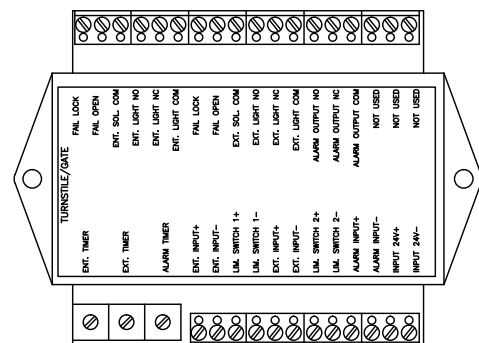

Control Board  
0789



# 6500 Series Control Head w/ XD10 Controller Standard Wiring Diagram

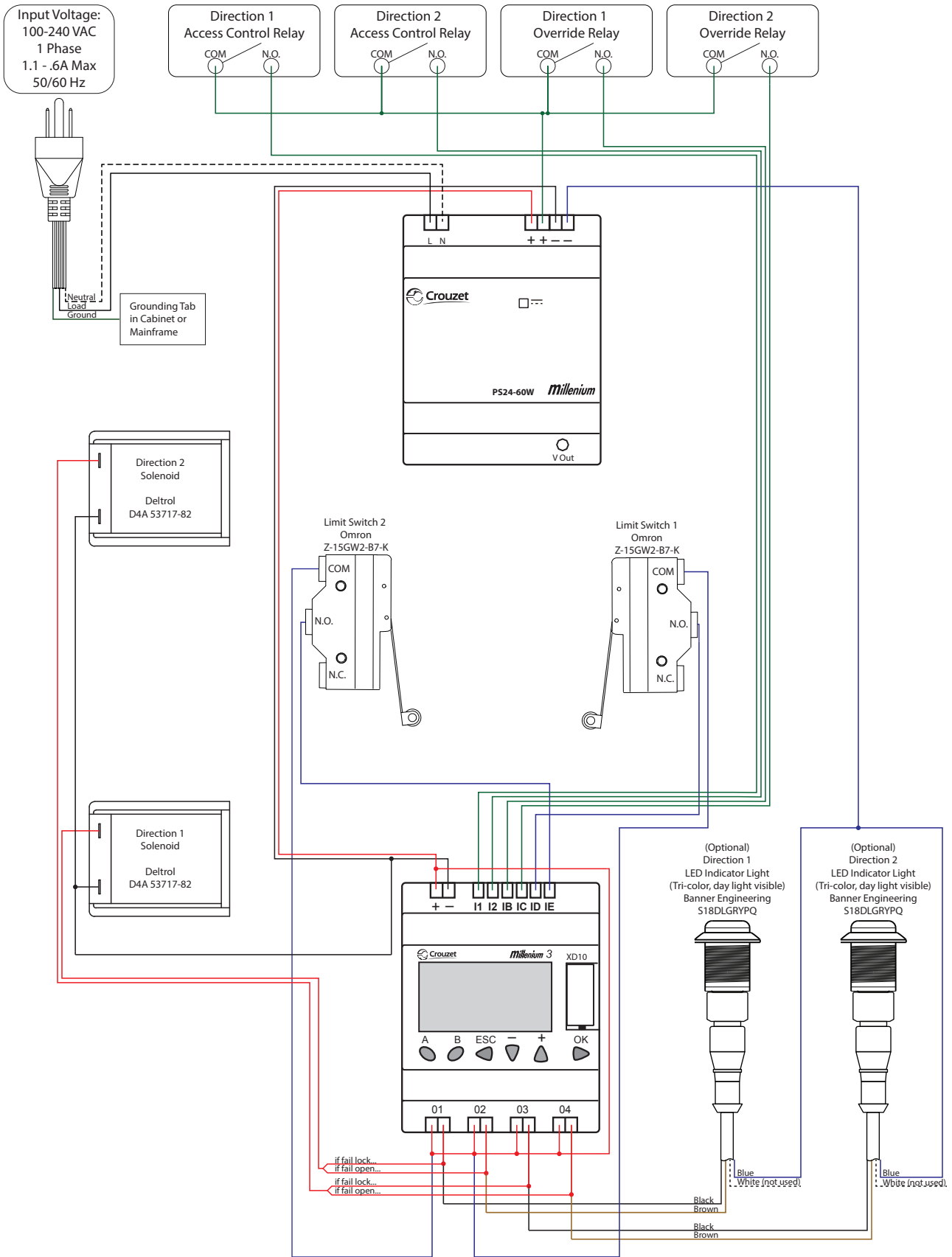

# 6500 Series Control Head w/ XD10 Controller Standard Wiring Legend

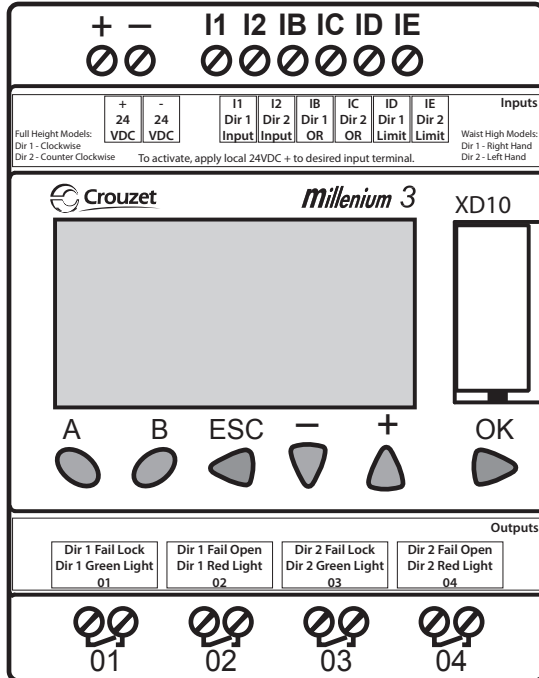

## General definitions:

**Direction 1** - Clockwise on full height turnstiles or cabinet on right for waist high turnstiles & ADA gates.

**Direction 2** - Counter clockwise on full height turnstiles or cabinet on left for waist high turnstiles & ADA gates.

**Limit** - A switch or sensor designed to detect rotation and lock the unit after a rotation.

**Fail Lock** - Upon power failure, the direction is designed to remain locked. Also known as Fail Secure.

**Fail Open** - Upon power failure, the direction is designed to remain opened. Also known as Fail Safe.

Each unit is built to order, preconfigured to function as specified at the time the order is placed. Some or all of the information listed may not be relevant to the installation.

Inputs are triggered with local 24VDC + (also known as PNP or sourcing).

Connect relay output from access control device to turnstile by terminating 24VDC + to relay common and the desired input to the relay's normally open terminal.

Be sure to disconnect power before wiring the board for safety.

Note: directional status outputs (lights) are unaffected by optional key overrides as the override occurs outside of the logic controller.

## Input descriptions:

**24VDC +** Positive output from the 24VDC power supply connects here.

**24VDC -** Negative output from the 24VDC power supply connects here.

**I1 - Direction 1 Input** - Unlocks direction 1 for either one rotation or until the timer expires. Standard access control should terminate here.

**I2 - Direction 2 Input** - Unlocks direction 2 for either one rotation or until the timer expires. Standard access control should terminate here.

**IB - Direction 1 Override** - Holds direction 1 unlocked for duration of contact closure. Mainly for fire alarms and other temporary overrides.

**IC - Direction 2 Override** - Holds direction 2 unlocked for duration of contact closure. Mainly for fire alarms and other temporary overrides.

**ID - Limit 1 Input** - Cancels Direction 1 activation if triggered before timer expires, re-locking the unit after one rotation.

**IE - Limit 2 Input** - Cancels Direction 2 activation if triggered before timer expires, re-locking the unit after one rotation.

## Output descriptions:

All 4 relay outputs have individual commons. 24VDC+ is distributed to each relay common to operate the turnstile. It is OK to add extra wires to these relay commons to distribute voltage to other devices.

**01 - Output 1** - Dual purpose output for Direction 1. If the direction is fail lock, it's solenoid would connect here. If equipped with an indicator light, the green leg would connect here. Output switches from OFF to ON when directional input is triggered.

**02 - Output 2** - Dual purpose output for Direction 1. If the direction is fail open, it's solenoid would connect here. If equipped with an indicator light, the red leg would connect here. Output switches from ON to OFF when directional input is triggered.

**03 - Output 3** - Dual purpose output for Direction 2. If the direction is fail lock, it's solenoid would connect here. If equipped with an indicator light, the green leg would connect here. Output switches from OFF to ON when directional input is triggered.

**04 - Output 4** - Dual purpose output for Direction 2. If the direction is fail open, it's solenoid would connect here. If equipped with an indicator light, the red leg would connect here. Output switches from ON to OFF when directional input is triggered.

## Indicator light information:

**Green Light** - An indicator to inform pedestrians that they are allowed to pass through the unit. Uses black output wire from light's cable.

**Red Light** - An indicator to inform pedestrians that the unit is locked or that pedestrians require credentials to enter. Uses brown output wire from light's cable.

As a side note, indicator lights purchased from Designed Security, Inc. can also be wired to glow **yellow**. If desired, this can be used instead of red with the unused white wire on the light's cable to indicate to pedestrians they require credentials to enter. This is especially handy for multi-lane installations in which some directions are "no passage" instead of "controlled passage". Likewise, green lights can also be wired to a red light output to constantly glow green to indicate "free passage".

## 6500 Series Control Head Limit Switch Information

Electronically controlled 6500 Series Control Heads utilize limit switches (or optionally, proximity sensors) in order to detect rotation. Depending on the type of unit (turnstile or ADA gate), the limit switch for a direction may be on the left or the right hand side of the control head.

### Turnstile Control Head

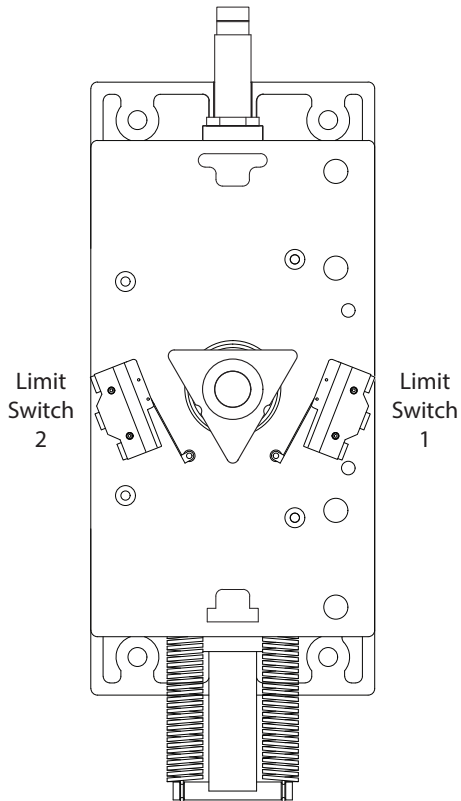

Turnstile control heads use a triangular shaped limit switch cam. One point of the triangle needs to be facing the index pin (bar with two springs) when the cam is in the home position. The two indents in the sides of the triangle are for jiggling purposes. It does not matter which point is facing to the springs.

The limit switch for direction 1 is on the right and the limit switch for direction 2 is on the left. In this configuration, the first limit switch triggered does not affect the unit. The second switch triggers after the half-way point of the rotation, which draws in the solenoid. This allows the rotation to go to home but prevents the rotor from backing in the other direction.

### ADA Gate Control Head

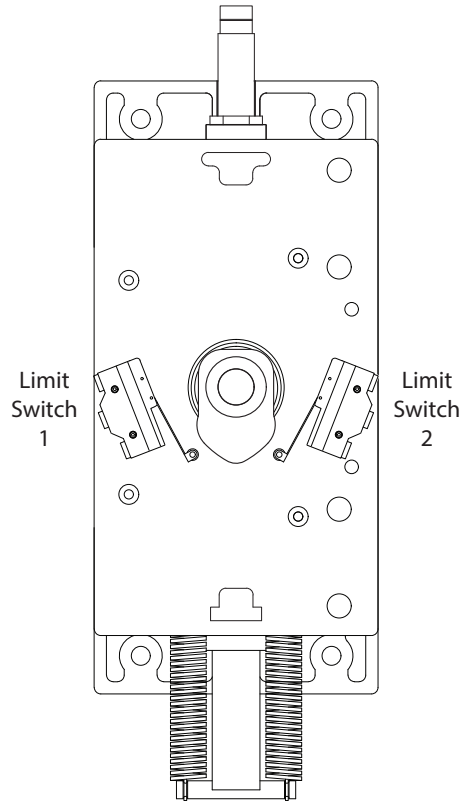

ADA Gate control heads use an oblong lobe shaped limit switch cam. The point of the lobe needs to be facing the index pin (bar with two springs) when the cam is in the home position.

The limit switch for direction 1 is on the left and the limit switch for direction 2 is on the right. In this configuration, the limit switch relevant to the swing is triggered after the cam leaves home position, which re-engages the locking bar. The cam is still free to move until it swings back to the home position.

Options and configurations may alter the quantity or layout of the limit switches. Some examples of this would be electronically controlled one direction turnstiles, turnstiles with counters and turnstiles equipped with home position switches.

# 6500 Series Control Head w/ XD10 Controller Standard Turnstile Settings

The XD10 logic controller on the 6500 Series Control Head has a text based menu screen to adjust settings and view statistics of the turnstile. Pressing the A button will cycle to each of the screens available on the device. Pressing B from any screen listed will return to the Home Screen.

## Home Screen

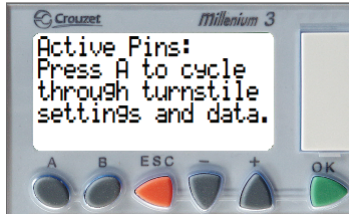

This screen is at the start of the menu cycle. The top section will give a read out of inputs that are currently receiving voltage. The display will return to this screen after cycling through all windows, 5 minutes of inactivity or pressing the B button.

## Timer Values Screen

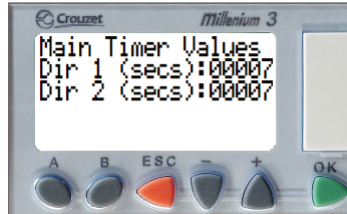

This screen allows for the each directional timer to be modified. Select which value you wish to edit by pressing the + & - key. Press OK to select the value then press + or - to modify. Save by pressing the OK button again. Each timer can have a value of 1 - 60 seconds. The timer will be canceled upon rotation of unit.

## One-Shot Timers Screen

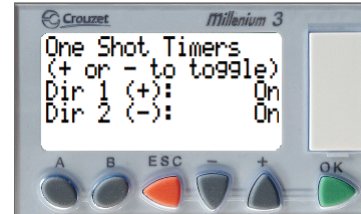

This screen allows for the two one-shot timer settings to be enabled or disabled. This setting prevents access control from holding open a direction on the standard direction inputs. Toggle Direction 1 by pressing + and Direction 2 by pressing -. This should be set to "On" in almost every installation.

## Swipe Queue Screen

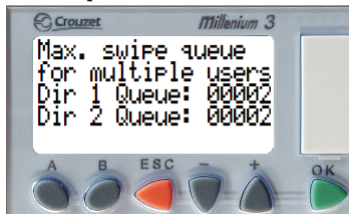

This screen defines the maximum number of access control requests the unit will allow in queue. Each value can be set from between 1 (for maximum security) to 3 (for fast paced passage). The default is 2. The method to change these settings is the same as the Timer Values Screen.

## Direction 1 Counts Screen

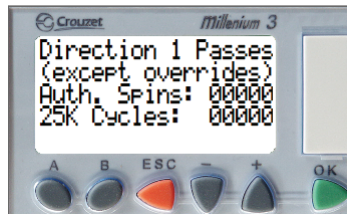

This screen gives statistics about how many times direction 1 was activated and cycled. Since there is a limit to how many counts can be displayed, after 25000 cycles the first counter resets and adds to the second counter.

## Direction 2 Counts Screen

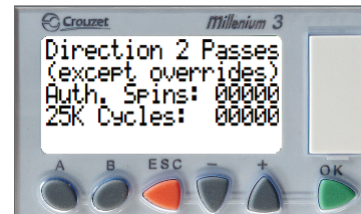

This screen gives statistics about how many times direction 2 was activated and cycled. Since there is a limit to how many counts can be displayed, after 25000 cycles the first counter resets and adds to the second counter.

## General Info Screen

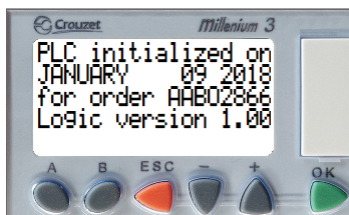

This screen displays when the PLC was initiated, the order number it was activated for (except for any revision suffixes which are not needed for order lookup), and the PLC software version.

## Testing Mode Screen

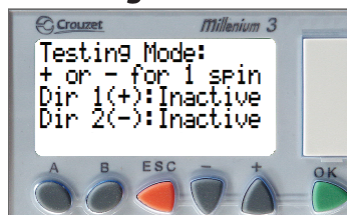

While this screen is active, the unit can be tested with push buttons to simulate access control inputs. See the page dedicated to testing for more information.

## Factory Setup Screen

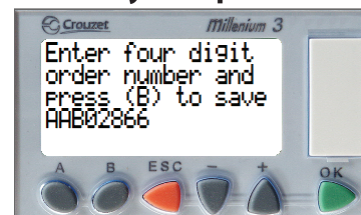

This screen should only appear when first set up in the factory or if something occurs to totally reset the logic controller. If this manages to occur and the order number (if known), enter it as a value then press B to save.

## 6500 Series Control Head w/ XD10 Controller Standard Turnstile Testing

The XD10 logic controller on the 6500 Series Control Head can be activated by contact closures between 24VDC+ and the relevant input. New technology allows for simpler on-board testing as well. To diagnose issues with the unit, press A on the keypad to cycle between screens until the testing mode screen appears.

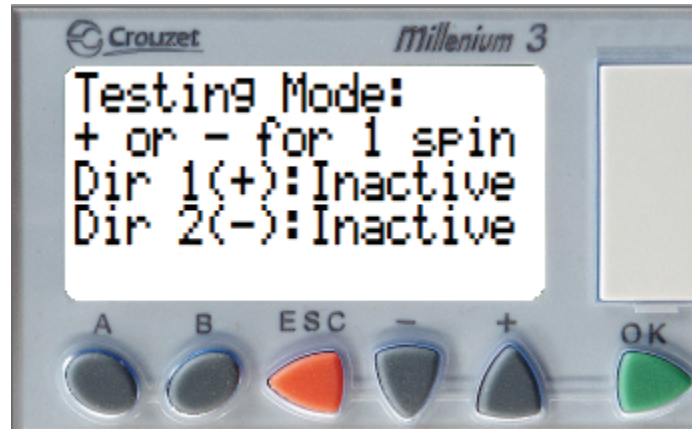

Testing mode simulates valid access control inputs based on the settings defined on the other menu screens. The unit should unlock for the duration of the directional timer or until the unit is rotated. If the button is pressed twice, it should allow two rotations or time out based on the multi-swipe setting. If the button is held and the one shot timers are disabled, the unit will continue to remain open until the button is released and another rotation or timeout occurs.

With the testing mode screen open, press and release + to activate in direction 1. The unit should unlock and allow one rotation. If the unit successfully functions this way, repeat the same for direction 2 by pressing the - button.

If everything is functioning properly from the menu test but not with access control, either access control is not connected properly, is normally closed instead of normally open, or is not properly configured. Contact a security integrator for assistance with help with the access control system.

If the unit successful unlocks but does not re-lock upon rotation, try to manually trigger the appropriate limit switch for the direction that is not working correctly. If this helps, it is likely that the limit switch is not properly being triggered by the limit switch cam. Either adjust the height of the limit switch cam or tweak the lever on the limit switch a bit closer to the limit switch cam's tip.

If the unit does not successfully re-lock after manually triggering the limit switch, ensure that it is wired properly. Return to the home screen and press / hold the limit switch. If the switch is being held but the "Active Pins" display does not include the switch being held, it may be necessary to replace the switch. Note that there is a short delay from when the switch is triggered to when the display will register it as active, however this is normal.

If there are other issues with operation, check out the troubleshooting guide for additional diagnostic procedures or call Designed Security, Inc. for assistance.

## Maintenance & Cleaning

To ensure long life on any turnstile, the following maintenance is recommended. Note: these figures are assuming a maximum 75000 passages per year. Turnstiles with heavier traffic should be maintained more frequently.

### Annual Servicing

- Secure all nuts & bolts throughout each model. This includes concrete anchors, carriage bolts holding together mainframes, and the bolts holding the control head assembly together.
- Remove the index pin assembly from the control head by disconnecting the two extension springs & apply white lithium grease. Use 3-in-1 oil on the index pin roller.
- If the unit is a High Security series full height turnstile, add grease to the rotor's roller bearing by utilizing the grease fitting fastened into the bottom of the rotor.

### Biennial Servicing

- Disassemble the control head by removing the 4x socket head cap screws holding the top casting to the bottom casting (and the triangular limit switch cam if equipped).
- Clean any loose debris / grease from the inside of the casting.
- Inspect internal components for wear and replace as needed.
- Apply 3-in-1 oil to the bronze bushings on the locking bar assemblies and shock piston.
- Apply white lithium grease to the shock piston where it enters the bronze housing.
- Reassemble the control head assembly, using removable strength (typically blue) thread sealer (such as Loctite 243) on the head bolts to ensure the assembly stays together.

### Cleaning

- Galvanized surfaces can be cleaned with soap and water. The finish may dull over time, but this is normal.
- Powder coated surfaces should be cleaned with a non-abrasive cleaner such as Formula 409. Inspect finish for chips and touch up as needed or the exposed steel may rust.
- Stainless steel surfaces should be polished with a stainless steel wax or polish. Contrary to common belief, stainless steel is not rust proof. Exposure to certain chemicals and harsh environments such as ocean air or chemical plants may cause surface corrosion. Minor discoloration can be removed with a rust penetrating product (such as PB Blaster) along with non-scratching scouring pads. Severe cases of contamination may require the use of specialty products. We have had great success with products such as Stellar Solutions' Citrisurf 2310 Rust Remover and Passivation Solution.
- For decorative solid surface tops use furniture polish (such as Scott's Liquid Gold Wood Cleaner). Allowing the product to soak into the material for a few minutes easily restores the surface's luster.
- Polycarbonate plastic should only be cleaned following the plastic manufacturer's recommendations. **DO NOT USE ANY PRODUCTS THAT INCLUDE AMMONIA OR OTHER HIGH PH PRODUCTS.** If the model purchased includes polycarbonate plastic, see the section of the manual dedicated to cleaning it (starting on the next page). Failure to use appropriate cleaning methods will cause aesthetic and structural damage to the plastic which will not be covered under the warranty.

Control heads can be removed from the turnstile and shipped to the factory at any time for repairs and maintenance. Please include contact information so we can call to discuss any issues your control head may have.

## 6500 Series Control Head w/ XD10 Controller Troubleshooting

Symptoms	Causes	Solutions
Turnstile does not power up or logic controller's display cycles on and off.	Power supply is not receiving input voltage.	Verify outlet receptacle installed in mainframe / cabinet is operating correctly and that the power supply is plugged in.
	Power supply is not producing 24VDC voltage, but is receiving AC.	Remove + lead from power supply output. If output voltage resumes, there is a short circuit in the wiring. If not, the power supply is faulty. Replace power supply.
	Short circuit in the wiring as determined in previous step.	Refer to pages 16-18 for wiring information.
	Loose wiring from power supply to logic controller.	
	Short circuit in the wiring.	
	Solenoid(s) burnt out (will occur if main AC voltage is connected directly to solenoid).	If wiring is correct, try to disconnect the solenoids from outputs 01 - 04. If system stops cycling, replace faulty solenoid.
Solenoid tabs grounded out against control head casting after being reassembled from maintenance or reconfiguration.	Disassemble control head casting and flip solenoids so that the tabs with wires are facing away from the center of the control head casting.	
Turnstile powers up but does not respond.	Solenoid (-) wire(s) not properly terminated.	Ensure solenoid negative wires are properly terminated to 24VDC- input and that the 3 wire splice (if equipped) is properly crimped.
	Improper wiring from access control to logic controller.	Ensure one leg of access control output relay is connected to 24VDC + and the other to the desired input.
	Access control device malfunction.	Disconnect access control from logic controller. Perform testing procedures on page 20. If the turnstile works properly, contact manufacturer of access control device.

## 6500 Series Control Head w/ XD10 Controller Troubleshooting

Symptoms	Causes	Solutions
More than one person can get through turnstile.	Access control device output connected to override inputs.	Wire access control to I1 or I2 with one-shot timer enabled.
	Access control device output set too long.	This can be avoided by enabling the one-shot timers built into the logic controller program. If this is undesirable, ensure the output from the access control system is one second or less.
	Loose wiring to the logic controller from limit switches.	Refer to pages 16-18 for wiring information.
	Limit switches are broken.	Inspect limit switches for breakage, replace as needed.
	Control head requires maintenance.	Refer to page 22 for more information.
	Limit switches are missing the triangular top cam.	Adjust the top cam to the proper height and/or tweak the triggers on the limit switch. Refer to page 21 for more information.
Turnstile only rotates 30 degrees.	Limit switches wired incorrectly.	Refer to pages 16-18 for wiring information and page 21 for limit switch placement.
	Limit switch cam is misaligned.	The top cam should have one point facing the control board. If this is not the case, readjust the top cam. Refer to page 21 for top cam information.
Unit remains unlocked until access control is presented.	Fail open / fail lock configuration is wired incorrectly.	Refer to pages 16-18 for wiring information.
Turnstile is slamming into the closed position.	Shock either needs adjusted or replaced.	Refer to page 15 for more information.
Turnstile is not centering properly.	Shock needs adjusted.	
	Binding in control head.	Ensure mainframe is level and the rotor is plumb. Shim the unit from the floor if necessary.
Turnstile seems to be binding mechanically.	Rotor is not plumb / turnstile body is not level.	



## 6500 Series Control Head w/ XD10 Controller Troubleshooting

Symptoms	Causes	Solutions
Unit remains locked after access control is presented until arm is pulled in.	Mechanical bind between locking bar and cam assembly (typically from unit being out of plumb or not level)	Remove locking bar assembly from control head (easiest way on non-key lock models is to punch out dowel pin pivot point from bottom side of head casting) and file down tip of locking bar to give clearance.
Turnstile rotating the wrong direction.	Improperly filled out direction sheet.	In some cases, the control head can be reconfigured in the field to operate as needed. Refer to pages 9-15 for information about how the control head operates. If needed, control heads can be returned to the factory for reconfiguration for a fee of labor plus parts (if required). Please contact us before returning a control head in this instance.
	Directional inputs wired incorrectly.	Refer to wiring legend on page 18 for direction port explanations.
Turnstile fails lock when needed to fail open or vice versa.	Improperly filled out direction sheet.	Refer to page 12 for more information. Additional parts will be required to convert operation. The control head can be returned for reconfiguration for a fee of labor plus parts (if required). Please contact us before returning a control head in this instance.
Unable to hold direction open to allow multiple people to pass through the turnstile.	Override wired to incorrect inputs.	Ensure the access control device dedicated to overriding passage is wired to the override input instead of the standard input for that direction.
	One-shot timers are enabled (on regular access control input).	Disable the one-shot timer settings on the logic controller. Be sure that your access control output is one second or less during regular secure operation or extra people may be able to pass through. Refer to pages 19.
Other problems.		Please contact us for any other issues.

## Proper Turnstile Usage

The 6500 Series Control head is easy to use. There are a few things that users should be trained on and informed of.

- In the case of an electronic turnstile, approach the unit and present access control credentials. Do not push on the arms of the rotor until after the access control device successfully unlocks the turnstile. A sturdy click sound will be heard from the main channel when the solenoid pulls the locking bar open.
- Note that the turnstile will not unlock the rotor is being pushed on before access control activates the solenoid. The unit should unlock once pressure is released but it is a better practice to wait until the unit is unlocked before pushing on the rotor.
- Once access has been granted, proceed through the turnstile immediately. Waiting too long could cause the rotor to time out mid-rotation, forcing the user to back out of the turnstile. There are timer settings for adjusting how long it takes for this to occur. The default time provided is 7 seconds. The reason for this is in case somebody swipes and walks away without passing through.
- Walk at a reasonable pace through the turnstile. Do not slam the rotor through the rotation. This can be unsafe and may cause unnecessary wear and tear to the control head.
- Try to be respectful of users wanting to pass through the opposite direction. Allow people who are waiting an opportunity to pass through the turnstile.
- Avoid rotating the rotor of a full height without being in the passage. This will cause the rotor to re-lock before you have a chance to pass through the turnstile.
- Piggybacking : More than one user trying to squeeze through the turnstile on one rotation should be avoided. Large bags and carts should be brought through an alternate means of entrance.

## Warranty Information



DESIGNED SECURITY, INC.

*A Detex Company*

The DSI Product you have purchased is warranted to be free of defects in material and workmanship when properly installed, used, and maintained according to instructions. DSI will, for a period of one (1) year, three (3) years for Optical Turnstiles, from date of purchase repair or replace any part which, upon our examination, prove to be defective under normal use. **DSI SHALL NOT BE LIABLE FOR ANY DIRECT, INDIRECT, INCIDENTAL, CONSEQUENTIAL LOSS, OR DAMAGE ARISING OUT OF THE FAILURE OF THIS DEVICE.**