

# ES880-N2 Desktop Controller

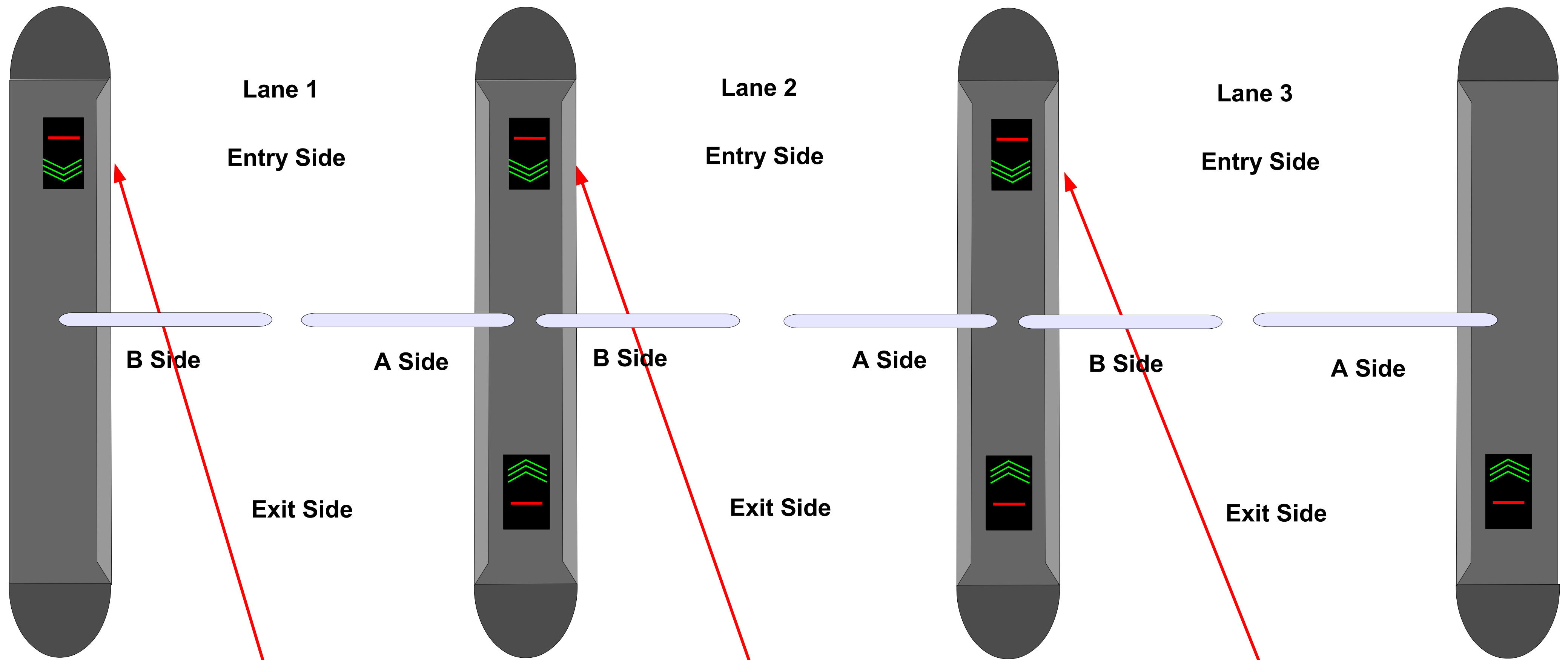

**BA Bridge Plate**  
Located on the "B" side of the turnstile

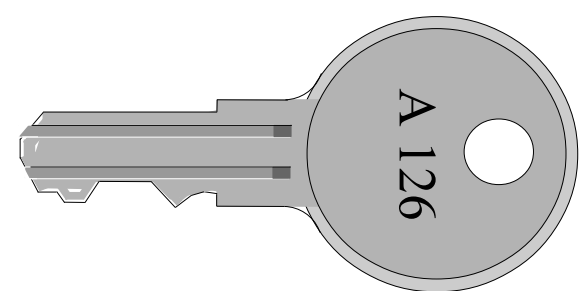

**K6 Key (Side View)**

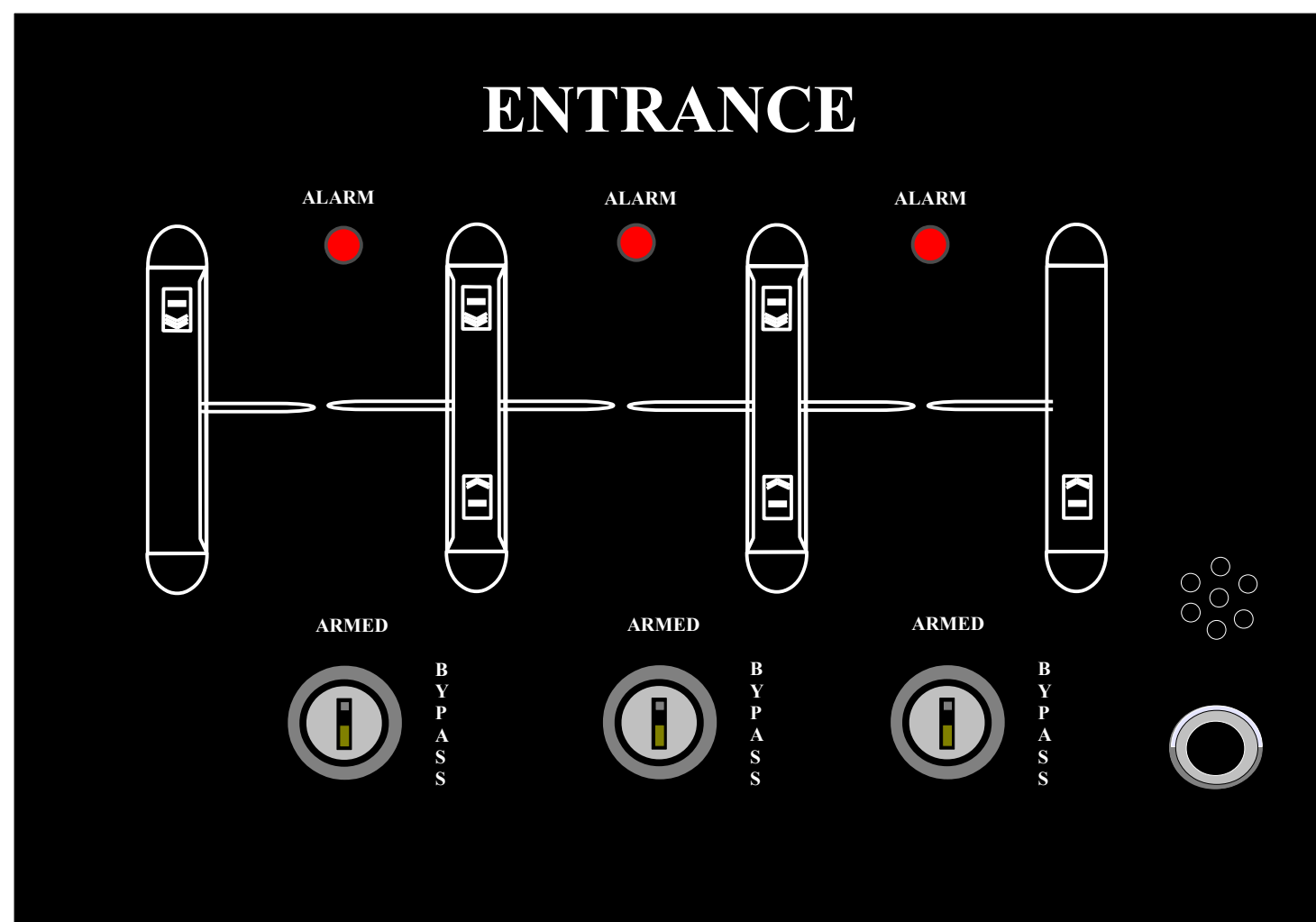
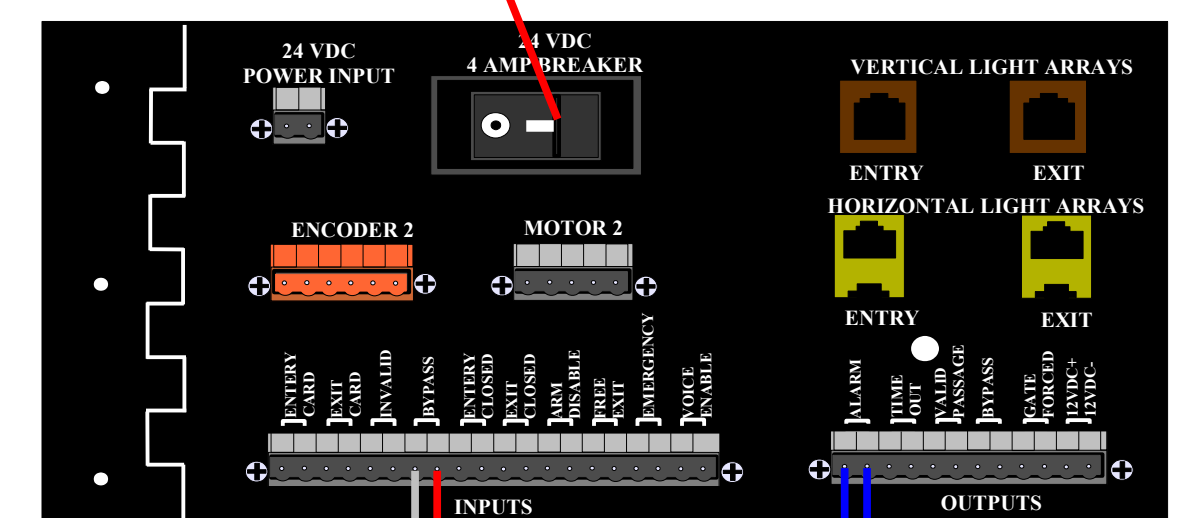
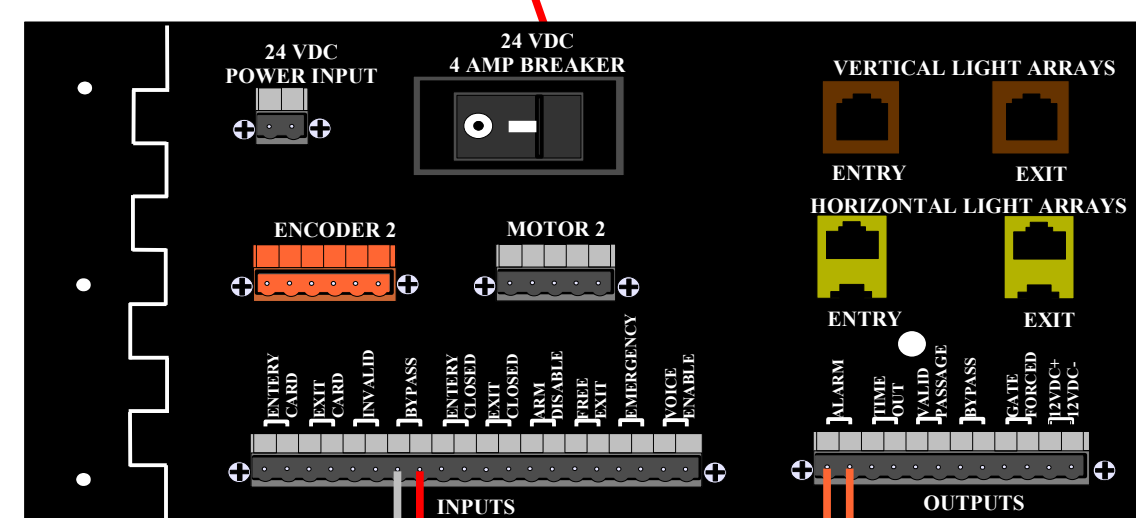
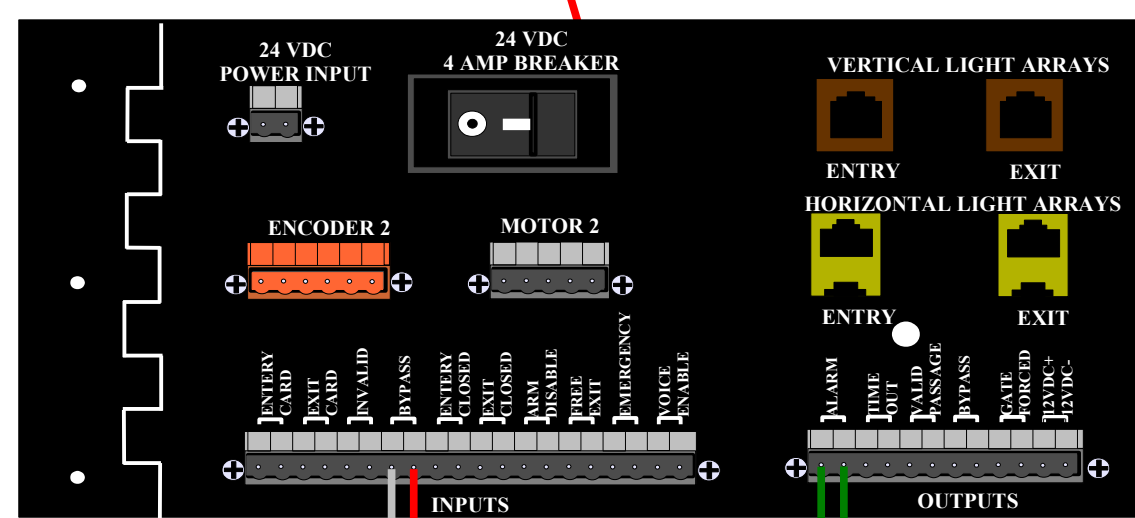

**Desktop Controller (Top View)**

**Note:** Wire Gauge:  
22 AWG = Signal wires  
22 AWG = Power wires  
(Power runs over 50 feet use 18 AWG)

**12 VDC 150mA Power Supply**  
*Sold Separately*

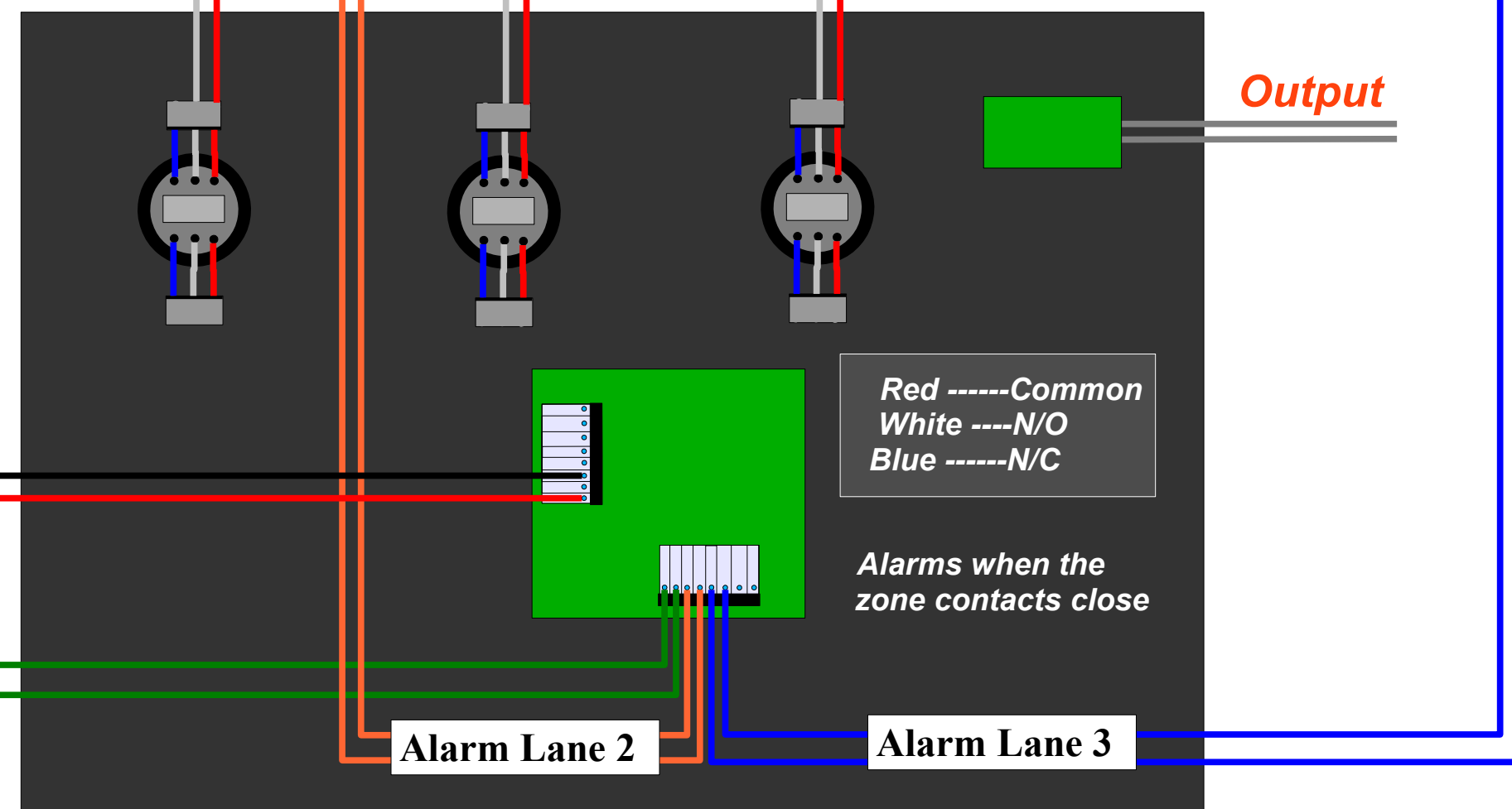

**Desktop Controller (Back View)**

**Desktop Specifications:**  
Power: 12VDC at (150mA)  
Input: N/O dry contact  
Output: Key Switch Status. "Form C" dry contact  
Output: Global Alarm Relay. "N/O" dry contact  
Horn Volume: 70 db